



VX565D Instruction Manual

Quick Start Guide

Not all features listed in this QSG
are available on all models.

THIS PACKAGE CONTAINS

Power/Speaker Harness	x 1
Remote control	x 1
Mounting Screws	x 4
Screw Covers	x 2
User's Manual	x 1

Installation the radio

Mounting the unit

Important! If any modification to the vessel is required, such as drilling holes, Velex recommends that you consult with your boat dealer or manufacturer beforehand.

- 1.Create mounting hole for product and drill screw pilot holes. Refer to mounting template included.
- 2.Fit mounting gasket.
- 3.Insert the unit into the mounting hole.
- 4.Use the supplied 4 x self tapping screws, to fix the unit into position.
- 5.Attach screw covers.

Note: Appropriate mounting is very important to ensure correct operation. Select a location that allows both free/ open airflow around rear of chassis, whilst minimizing exposure to moisture. Allow adequate room at the rear of the unit for the cable looms (approx. 50mm or 2")

The heatsink must not be mounted on more than a 45 degree angle from the horizontal plain. Failure to following restrictions could void your warranty.

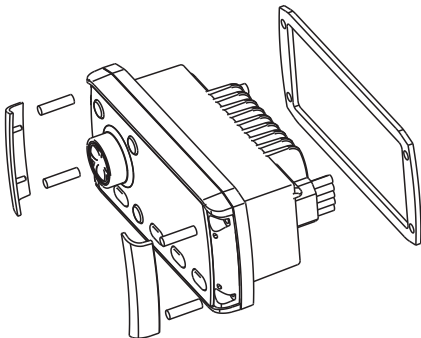
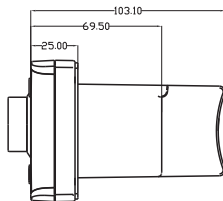

Figure 1 – Locating the VX565D unit into the mounting panel



Caution! These images are not to scale, Dimension are shown in millimeters(mm) and inches(“).

Mounting Cut Out Diagram

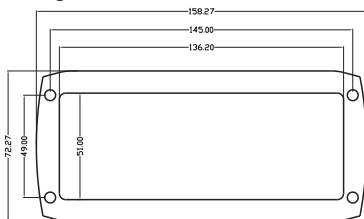

Figure 3- Cutting size diagram for installing the VX565D unit (not to scale)
A 1:1 scale mounting diagram is provided in the box.

INSTALLION WARNING

Caution! The VX565D is designed for vessel with 12V DC negative ground electrical system. Ensure the marine vessel's +12V lead is removed from the battery before any equipment is connected.

Investigate the marine vessel's fuel tanks and electrical wiring locations before you begin installation.

Ensure all wiring is protected to avoid damage.

When wiring the VX565D, ensure that the wires are away from sharp objects and that rubber grommets and insulated bungs are used when routing the wiring. Ensure that when connecting the wires to the speakers and audio system. The terminals and connections are protected from shorting to each other.

Note: Ensure the Aerial cable is routed away from any power cables, and is the minimal length, as long cable runs will affect AM reception performance.

For optimum radio reception, please ensure you use an independent FM marine antenna and a separate DAB+ antenna with SMB connector (FM and DAB+ antenna are not included).

WIRING DIAGRAM

Connections and cables on the VX565D are described below.

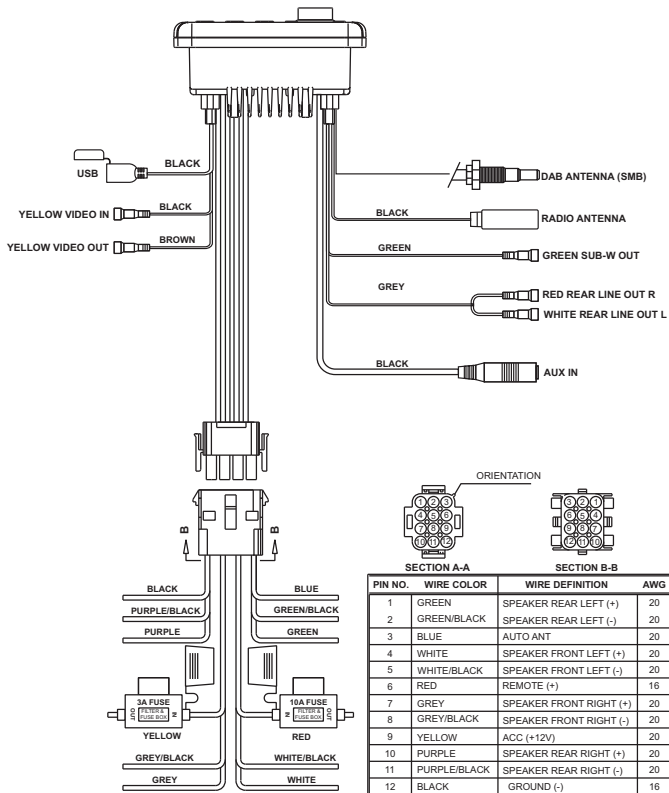

Control Locations - Receiver

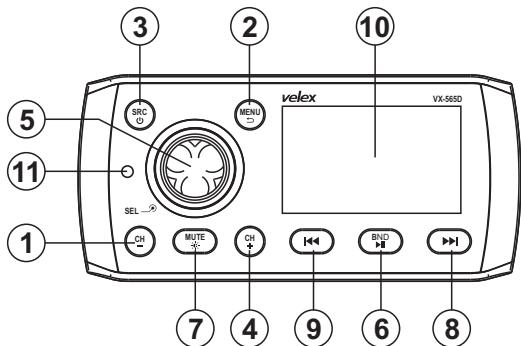

- 1 Next Preset Stations (Radio –AM/ FM/DAB+)
- 2 MENU / Return
- 3 Source / Power
- 4 Previous Preset Stations (Radio –AM/FM/DAB+)
- 5 VOL Knob (Rotate) / Confirm (Press)
- 6 Play / Pause | Band (Radio) | Video I/O Switch (Press and Hold While Playing Video)
- 7 MUTE / Button Backlight dim
- 8 Tune Up / Next Track
- 9 Tune Down / Previous Track
- 10 TFT Display
- 11 Infra red wireless remote

General Operation

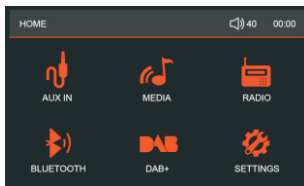

Power on/off – Press the " button to turn the unit on. Press and hold " to turn unit off.

Changing Modes – Press 'SRC' button to switch between Radio, AUX IN, Bluetooth Music, Media (USB), DAB+ modes. .

MENU – Press MENU button and use the Volume Knob to select between MEDIA, RADIO, BLUETOOTH, AUX IN, SETTINGS. Short Press the Volume Knob to confirm the selection.

Settings – Select 'SETTINGS' from MENU to set System time, Time format (12/24 hours), Language, Radio Region (Europe/American), Restore Factory Setting, Software Version.

Volume – Rotate the Volume Knob to adjust volume (AUX IN/MEDIA/RADIO/BT /DAB+ modes)

When the volume level interface is still on display, quick press the Volume Knob to enter settings for BAS, MID, TREB, BAL, FAD, SUB, LOUD OFF, EQ in sequence, then rotate the Volume Knob to set the required level. Use MENU/RETURN button to quit setting or wait for time out to return to the previous status.

MUTE / ☀️ ' Long press 'MUTE/ ☀️ ' to dim/resume the back light

Radio Operation

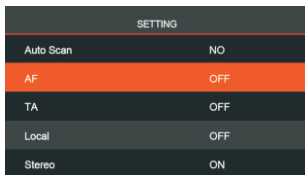
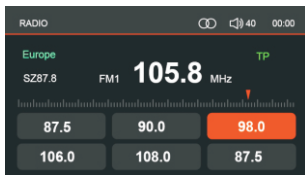

Seek Tuning – Press and hold << or >> for more than 1 second to seek the next strong station.

Manual Tuning – Press << or >> momentarily to move radio frequency up or down one step at a time.

Long press VOL button to save into PRESET.

Auto Programming of Radio Station – Long press MENU button to activate Radio Setting, select AUTOSCAN and YES, VX565 will commence searching the band for radio stations and automatically stored in the available preset memory location. The new stations will replace any stations previously stored in that band.

Band – Press BND >|| to select between FM1, FM2, FM3. Up to six presets can be programmed for each band. Enabling up to 18FM stations to be stored in memory.

Recalling Presets – Press the CH+/CH- button to cycle through the 1-6 presets in the current band.

Long press 'MENU' button to activate Radio Setting (AUTOSCAN, LOC/DX, STEREO, RDS TA/AF)

RDS AF/TA function

AF on/off

ON: The unit will search for another station with stronger signal, but with the same program identification as the current station automatically.

OFF: Turn off AF function

TA On/Off

ON: When there is traffic announcement, unit will automatically switch to the tuner mode (regardless of the current mode) and begins to broadcast the announcement

OFF: Traffic announcement does not cut in;

MP3 / WMA Operation

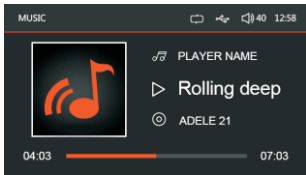

When an USB stick is plugged in, VX565D start to play the audios from the first location.

If user want to play MOVIE/PHOTO on the USB stick, press MENU then enter MEDIA selection, MUSIC/MOVIE/PHOTO will be displayed on LCD screen, rotate the VOL Knob to make choice.

Pause – To pause the audio/video, press the >II button once.
Press the >II button again to resume playing.

Track Select – Press >> to skip to the beginning of the next song.
– Press << to skip to the beginning of the previous song.

Short press VOL Knob and the song list will be displayed on the screen, rotate the Vol Knob to select the desired song and press 'VOL' to confirm the selection.

Rotate the Volume Knob to adjust volume, when the volume level interface is still on display, quick press the Volume Knob to enter settings for BAS, MID, TREB, BAL, FAD, SUB, LOUD OFF, EQ in sequence, then rotate the Volume Knob to set the required level. Use MENU/RETURN button to quit setting, or wait for time out to return to the previous status.

Fast Forward and Reverse – Press and hold >> or << to fast forward or reverse a track.

FOLDER SELECT

When playing music, short press VOL knob, the song list of current folder will be displayed on the screen, rotate the VOL knob and select your favorite song, short press VOL knob to confirm the selection.

When the song list is displayed, short press 'MENU/RETURN' button to show all the available folders in the USB sticks, rotate VOL knob to select the wanted folder and confirm the selection.

Long press MENU button, activate the REPEAT (ONE,FOLDER,ALL,OFF), RANDOM, INT option.

MUSIC/VIDEO/PHOTO Operation

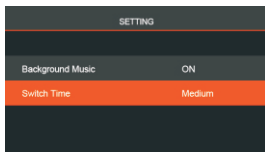
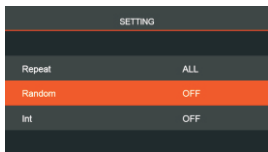
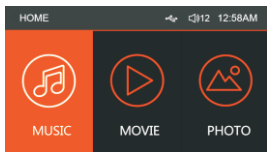

When an USB stick is plugged in, VX565D will auto detect the audio files and start to play from the first location.

When VX565D is playing audio, press and hold the VOL knob for 1 second, MUSIC /VIDEO/PHOTO selection will be toggled, rotate and press the VOL Knob to confirm the selection.

Or press MENU button and select MEDIA, MUSIC/VIDEO/PHOTO selection will be triggered, rotate and press the VOL knob to confirm the selection.

When VIDEO is selected, short press VOL knob and the video list will be displayed on the screen, rotate the VOL knob to select the desired video and press 'VOL' to confirm the selection.

Rotate the Volume Knob to adjust volume, when the volume level interface is still on display, quick press the Volume Knob to enter settings for BAS, MID, TREB, BAL, FAD, SUB, LOUD OFF, EQ in sequence, then rotate the Volume Knob to set the required level. Use MENU/RETURN button to quit setting, or wait for time out to return to the previous status.

Rear view camera installation, power up camera and connect it to 'video' in cable. Then go to the AUX mode to check the rear view video.

When PHOTO is selected, VX565D will automatically display the photos by slide show.

Long press 'MENU' button to activate MEDIA settings. (REPEAT/RANDOM/INT for Music and Movie, Back Ground Music on/off and slide show time setting for Photo)

Bluetooth Operation

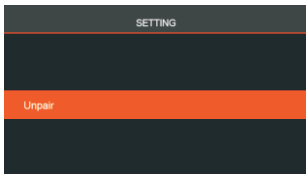
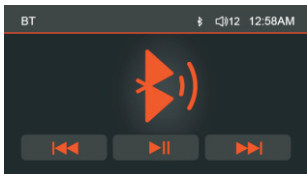

Preparation – Before using a Bluetooth device, it must be paired and connected. Ensure that Bluetooth is activated on your device before beginning the pairing process.

Activate the Bluetooth on your smartphone to search for new devices. Connect with the device name 'VX565' when founded. Once pairing is successful, '  ' icon on the top title will change into blue color which means 'device paired'.

Note: The head unit can be in any mode of operation when pairing is performed.

After paired, select BT mode from MENU, BT music interface will be displayed on screen, now select and play your desired music on your smart phone or media player.

The head unit supports A2DP wireless streaming audio from a Bluetooth mobile device directly to your head unit. The following function can be used to control the music:

Press >> to skip to the next available audio track.

Press << to skip to the previous audio track.

Press >/|| to toggle between play and pause during playback.

Long press 'MENU' button to activate the 'UNPAIR' setting, which enable to unpair the current Bluetooth.

DAB+ Operation

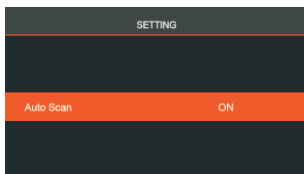
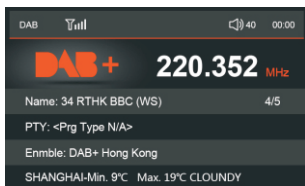

Select DAB+ from MENU or press SRC button to switch to DAB+ mode, VX565D will automatically scan for local digital stations. This process may take a few seconds depending on the numbers of stations available. As DAB+ stations are found, they will be automatically stored into the DAB band memories. Once scanning is complete, VX565D will begin playing the station stored in the first memory location. And the station info will be displayed on the screen.

Tuning DAB stations

Press CH+ or CH- button to tune to next/previous DAB station.

Auto Programming Station

Long press 'MENU' button and select 'AUTOSCAN'-'YES'to manually force a new station search.

Long press 'MENU' button to activate DAB+ settings. (AUTOSCAN)

Trouble Shooting

ISSUE	OPTIONS
Unit will not turn on (no power)	Cause: Yellow/red wire not connected or incorrect voltage Action: Check connections for proper voltage (11-16V DC)
	Cause: Black wire not connected Action: Check connection to ground
	Cause: Fuse blown Action: Replace the fuse
Unit has power (but no sound)	Cause: Speaker wire not connected Action: Check connections at speakers
	Cause: One or more speaker wires touching each other or touching chassis ground Action: Insulate all bare speaker wires from each other and chassis ground
Unit blows fuses	Cause: Yellow/red wire touching chassis ground Action: Check for pinched wire
	Cause: Speaker wires touching chassis ground Action: Check for pinched wire
	Cause: Incorrect fuse rating Action: Use fuse with correct rating

Specifications

General

Power supply requirements: DC 12V Negative Ground

Load impedance: 4 Ohms/channel

Maximum output power: 40W x 4 (CH)

Operate temperature: -10-50°C

MULTIMEDIA SUPPORT

AUDIO FORMAT: MP3/WMA/OGG/FLAC/APE/AAC/AC3

VIDEO FORMAT: MPEG 1/ MPEG 2/ MPEG 4-XVID/DIVX/H.264/H.263/WMV9/RMVB

PHOTO: JPEG/BMP

FM Tuner: Tuning range: 87.9MHz-107.9MHz (USA)
87.5MHz-108MHz (EUR)

DAB+: Tuning range: BAND III 174-240 MHz

USB playback

Signal to Noise Ratio: 55dB

Frequency Response: 20Hz- 20KHz

A/D Conversion Filter: 16BIT

USB Storage Capacity: 16GB Max

Bluetooth

Version: 4.0

*Note: Specification may change without notice.