

*Thank you for purchasing this*

**LUFTMUSIC**

**LM402 Bluetooth Amplifier**

Please read through these instructions carefully so you will know how to operate your model properly.

After you have finished reading the instructions, keep this document in a safe place for future reference.

**THIS PACKAGE CONTAINS**

1-LM402 Bluetooth 4-CH Amplifier



1-Wireless Remote Control



1-Flush Mount Bezel (preinstalled on the remote)



1-User Manual



---

**LUFTMUSIC**

---

## BEFORE YOU START

### IMPORTANT SAFETY PRECAUTIONS

- BE SURE TO OBSERVE THE FOLLOWING GUIDELINES:
  - Do not turn up the volume so high that you can't hear what's around you.
  - Use caution or temporarily discontinue use in potentially hazardous situations.
- Do not operate mobile video equipment while driving a motorized vehicle - safe driving and safety consideration of others should always be your highest priority.
- Set your volume control at a low setting, then slowly increase the sound until you can hear it comfortably without distortion, or ear discomfort.
- In the event you should notice smoke, strange noises or odor from this product, or any other abnormal signs, immediately turn off the power and consult technician. Using this product in this condition may result in permanent damage to the system.

### INSTALLATION PRECAUTIONS

#### **WARNING** *Always consult with a professional installer*

- Do not attempt to install or service this product by yourself. Installation or servicing of this product by persons without professional training and experience in electronic equipment and motorized vehicle accessories may be dangerous and could expose you to the risk of electric shock, injury or other hazards.
- **LM402** should be powered directly to a vehicle battery
- When wiring directly to vehicle battery, be sure to disconnect the batteries negative terminal wire before starting any wiring procedures, if extending the main power wire, it is suggested that an optional fuse and fuse holder (not included) with minimum rating of **20 Amperes** be in-line with the positive battery terminal.
- The ground cable length should not exceed 18-inches (See wiring diagram PG 4)
- The **LM402** has a weather resistant design, it should not be submerged in or under water under any circumstances
- Use only the installation parts provided with the **LM402**



**CAUTIONS!!** *Using other mounting methods may void this warranty*

# WIRE DIAGRAM

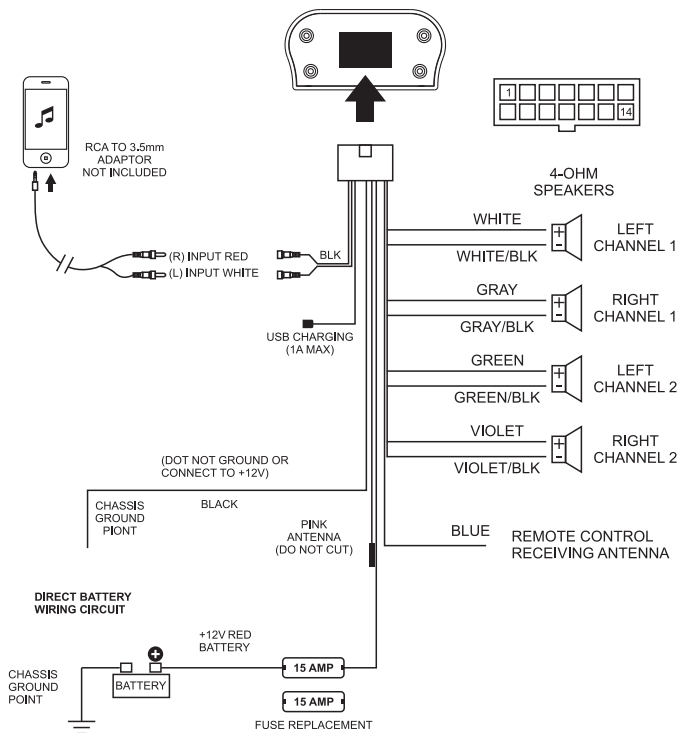

**CAUTION!! Do not ground or short the PINK antenna wire**

## BEFORE INSTALLING THIS PRODUCT

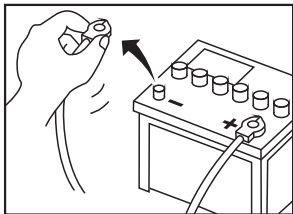

To avoid potential shorts in the electrical system, be sure to disconnect the (-) battery cable before installation. Use this unit with a 12-volt battery and negative grounding only. Failure to do so may result in a fire or malfunction.



When replacing the fuse, be sure to only use a fuse of the rating specified on this product.

To avoid short-circuiting, cover any disconnected lead with insulating tape. It is especially important to insulate any unused wires, which if left uncovered may cause a short circuit. When connecting other devices to this product, refer to the manual for the product to be connected. The black cable is ground, make sure to connect the ground wire first.

Ensure that the ground cable is properly connected to metal parts of the vehicles body frame or direct to the battery if your vehicle does not have a grounded chassis frame. The ground cable of this units power amp and a second powered system must be connected to the frame separately with different screws. If the screw for the ground wire loosens or falls out, it could result in fire or malfunction.



### **TOOLS NEEDED:**

- Wrench and/or Pliers
- #2 Philips screwdriver
- Crimp tool
- Electrical tape

## SUGGESTED MOUNTING METHODS

The **LM402** can mounted in two different configurations:

### 1 Flush Mount

The flush mount quick mount bezel requires no screws  
Use cutout dimensions:  
3.15" W x 1.85" H  
(80mm x 47mm)

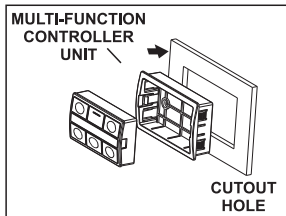

### 2 Surface Mount

- The flush mount bezel can be fixed at any convenient position with the 3M tape included in the package.
- The flush mount bezel also has 2 recessed screw holes to facilitate the included two over-head screws.

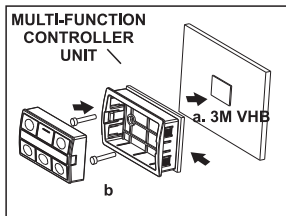

### 3 Caution

Remote needs to be charged once a year, 5V DC Input (Type C). Suggest to use power bank with 5V output to recharge the remote. The green charging indicator (button ►► ④) will go out when the remote is fully charged. Use a screw driver (not included) to release remote controller from mounting base. ①②

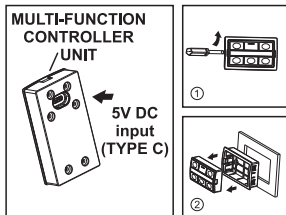

**Tips:**

To release the **LM402** controller from the mounting bezel, insert a small jewelers screwdriver into the left/right slots of the bezel.

## GETTING STARTED

### GETTING TO KNOW YOUR LM402 MULTIFUNCTION CONTROLLER (MFC)

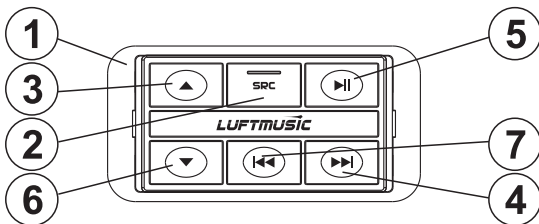

- 1 MFC-MULTIFUNCTIONAL CONTORLLER
- 2 SRC-POWER ON/OFF,  
SWITCH AUX IN / BT MODES (GREEN LED INDICATION)
- 3 VOLUME UP
- 4 NEXT TRACK / FAST FORWARD
- 5 PLAY / PAUSE
- 6 VOLUME DOWN
- 7 PREVIOUS TRACK / FAST REWIND

## BLUETOOTH OPERATION

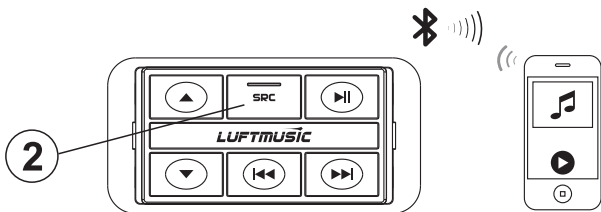

### PAIRING & DISCOVERING A NEW BLUETOOTH CONNECTION

1. Power on the **LM402** by short press the **SRC** (2) button, wait for 2-3 seconds, 'Power On, Audio In Mode' will be heard, signaling that **LM402** is now ready for **Audio In**.

2. Press **SRC** (2) button again and switch to 'Bluetooth Mode' with voice indication, now **LM402** is ready for Bluetooth pairing.

#### **Android users:**

- Go into the Setting Menu of your device
- Enter the Bluetooth Menu and press SCAN
- LM402** will now be display under AVAILABLE DEVICES
- Select **LM402** and 'Bluetooth Connected' will be heard after paired.

#### **iOS users:**

- Go into the Setting Menu of your device
- Enter the Bluetooth Menu
- LM402** will now be displayed
- Select **LM402** and 'Bluetooth Connected' will be heard after paired.

3.If the **LM402** is not seen, repeat the above steps to refresh the "Device List".

4.When the connection is successful ,you are now ready to stream music from your devices favorite media player to the **LM402** Please adjust the volume of your smart phone to a reasonable level.

5.Press and hold **SRC** button to power off **LM402**.

6.The remote control has been paired at the factory, the below operation is only required when the remote control fails or replaces with a new one.  
To pair new remote to **LM402**, press and hold **SRC** button until voice indication " Remote Control Paired, Power On' then **LM402** is now in Standby.

## BLUETOOTH OPERATION

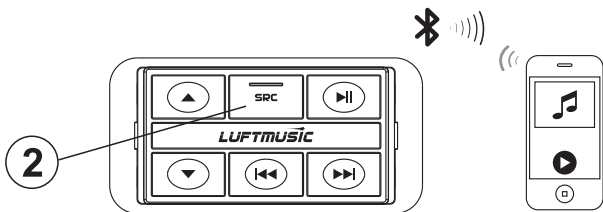

### RECONNECTION

1. Power on the **LM402** and your last paired Bluetooth Device;
2. The unit will now automatically reconnect;
3. If your device was previous paired with **LM402**, but it wasn't the last paired device:
  - a.Ensure no other devices are currently paired
  - b.Enter the **Bluetooth Menu** on your device being paired
  - c.**LM402** will display under **AVAILABLE DEVICES**
  - d.Choose the **LM402** to reconnect
4. If the device is out of range from **LM402**, it will disconnect automatically;



## STREAMING MUSIC

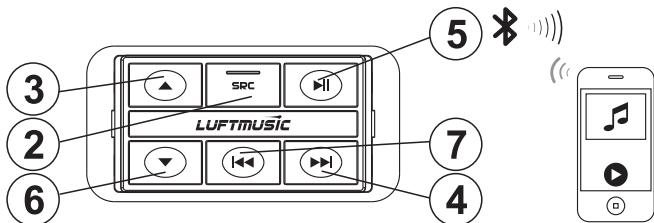

### MULTIFUNCTIONAL CONTROLLER BLUETOOTH OPERATION

1. Press the **(5) PLAY/PAUSE** once to start playing music or press the **PLAY** button from your device touch screen, pressing again to **PAUSE**
2. To skip songs or advance, press the **NEXT TRACK (4)** button, press and hold to **FAST FORWARD**
3. To select the previous song, press the **PREVIOUS TRACK (7)** button, press and hold to **FAST REWIND**

### VOLUME CONTROL

1. To raise the **VOLUME** press **UP (3)** button
2. To lower the **VOLUME** press **DOWN (6)** button



**Tips:**

Turn the **BLUETOOTH** volume level on your device to its 100% level

**LUFTMUSIC**

## AUX-INPUT

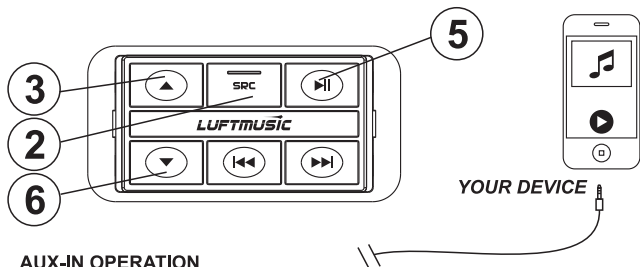

### AUX-IN OPERATION

**Lm402** can play audio from any device that has a pair of RCA output

1. Power on the **LM402** by short press **SRC** (2) button and wait for 2-3 seconds, there is voice indication to confirm **LM402** is switched on and ready for **AUDIO IN** mode.
2. Connect the integrated **RCA AUDIO-IN** cable on the amplifier (if you have a 3.5mm jack device, please use the 3.5mm to RCA adaptor cable (not included, please purchase separately from shops)
3. Route the audio wires back to a convenient storage place, secure your device.
4. Bluetooth devices will remain paired even in **AUDIO-IN MODE**.

### VOLUME CONTROL

1. To raise the **VOLUME** press **UP** (3) button
2. To lower the **VOLUME** press **DOWN** (6) button
3. To **MUTE / UN-MUTE** the **VOLUME** press **PLAY / PAUSE** (5) button



#### Tips:

Turn the **SMART PHONE** volume level on your device to its 100% level

## TROUBLE SHOOTING GUIDE

<b>TROUBLE</b>	<b>CAUSE</b>	<b>SOLUTION</b>
Unit will not turn on	The fuse is blown	Check / replace the fuse
	Ignition not engaged	Turn ignition to on position
No sound is heard	Blown speaker	Replace faulty speaker
	Volume is low / muted	Press the volume level up
	Device is paused or muted	Check your devices playing / volume status
Can not pair Bluetooth	The Bluetooth function of the device is not enabled	Refer to the user manual of the device for how to enable the Bluetooth function
The audio quality is poor after connection with a Bluetooth enabled device	The Bluetooth reception is poor	Move the device closer to the audio system or remove any obstacle between the device and the systems antenna
Unit has become unresponsive	Power glitch or interference	Disconnect power for 10 seconds to reset

## SPECIFICATIONS

### **BLUETOOTH**

- BT: 5.0
- BT Range: 33FT / 10 M (CLASS 2)
- BT Profiles: A2DP

### **AMPLIFIER**

- Channels: 4
- **MAX** Continuous Output: 200W (All channel driven)
- **PEAK** Power Rating
- **RMS** Total Power Output: 50W
- Class AB
- Frequency response: 20-20KHz
- 4 Ohm stable
- Input impedance: 22K Ohm

### **CHASSIS**

- Dimension: W x L x H  
99 x 150 x 50 mm
- Controller Dimensions W x L x H  
47 x 80 x 22 mm
- Wireless Controller

### **GENERAL**

- Power source: 14.4VDC (10.8 - 16V Allowable)
- Grounding System: Negative type
- Maximum Current Consumption: 15A
- 3-way protection circuitry (thermal, overload, and speaker short protection)
- USB output voltage: 5VDC @1A
- Unit weight: 1.5lbs / 0.68kgs
- Storage Temperature: 5 F to 113 F / - 15 to 45 degree
- Replacement Fuse: 15A
- 

(Replace with ATO Fuse Type Only).